

USER MANUAL

Cold-Hot Well



Installation Variants: plug in

Cold-Hot Well GN1

Cold-Hot Well GN2

Cold-Hot Well GN3

Cold-Hot Well GN4

Remote Cooling System

Cold-Hot Well – Z GN1

Cold-Hot Well – Z GN2

Cold-Hot Well – Z GN3

Cold-Hot Well – Z GN4

On Counter Variant

Cold-Hot Well – A GN1

Version: 12/2020

E

Keep the manual handy with the device!

1. GENERAL.....	4
1.1 INFORMATION ABOUT THE USER MANUAL	4
1.2 LIABILITY AND WARRANTY	4
1.3 COPYRIGHT	4
1.4 DECLARATION OF CONFORMITY	5
2. SAFETY.....	5
2.1 GENERAL	5
2.2 SAFETY INSTRUCTIONS FOR USE OF THE DEVICE	5
2.3 INTENDED USE.....	6
3. TRANSPORT, PACKAGING AND STORAGE.....	7
3.1 TRANSPORT INSPECTION	7
3.2 PACKAGING.....	7
3.3 STORAGE	7
4. TECHNICAL DATA	8
4.1 TECHNICAL SPECIFICATIONS.....	8
4.2 PRODUCT DIAGRAM	9
4.2.1 <i>Installation Variant – plug-in (diagram size GN1)</i>	9
4.2.2 <i>Installation Variant – Remote Cooling System (diagram size GN1)</i>	9
4.2.3 <i>On Counter - (diagram size GN1)</i>	10
4.3 SCOPE OF SUPPLY.....	10
5. INSTALLATION AND OPERATION.....	11
5.1 SAFETY INFORMATION	11
5.2 INSTALLATION AND ELECTRIC CONNECTION	12
5.2.1 <i>Installation (only valid for installation variants)</i>	12
5.2.2 <i>Electrical connections</i>	12
5.3 OPERATION.....	12
5.3.1 <i>Control panel</i>	13
6. CLEANING AND MAINTENANCE	14
6.1 SAFETY INSTRUCTIONS FOR CLEANING	14
6.2 CLEANING	14
6.3 SAFETY INSTRUCTIONS FOR MAINTENANCE	15

6.4 MAINTENANCE	15
7. POSSIBLE MALFUNCTIONS	16
8. DISPOSAL.....	17
9. CONFORMANCE DECLARATION	18

1. GENERAL

1.1 Information about the user manual

This user manual describes the installation, operation and maintenance of the device and serves as an important source of information and reference.

The knowledge of all safety and handling instructions contained in the user manual creates the conditions for the safe and proper operation of this device.

In addition, you must comply with all relevant local accident prevention regulations and safety regulations concerning the permitted uses of the device.

The user manual is part of the product and must be accessible at all times in the immediate vicinity of the device for the installation, operation, maintenance and cleaning staff.

1.2 Liability and Warranty

All information and instructions in this user manual have been compiled in accordance with current regulations, the current state of engineering technology and our many years of knowledge and experience.

The actual scope of delivery may differ for special designs, utilization of additional order options or due to the latest technical changes to the explanations and representations described herein. In case of questions, please contact the manufacturer.



NOTE!

This user manual should be read carefully before starting work on and with the device, in particular before commissioning! The manufacturer accepts no liability for damage and faults that arise from non-compliance with the operating instructions.

The user manual must be kept directly on the device and accessible to all persons working on or with the device. We reserve the right to make technical changes to the product in the context of improving the usage properties and further development. Our current user manual can be downloaded online from our homepage.

1.3 Copyright

The user manual, including any text, drawings, images and other depictions, is protected by copyright. Reproduction in any manner and form - including excerpts - as well as the utilization and/or communication of the content is forbidden without permission in writing from the manufacturer. Any non-compliance is liable for damages. All other rights are reserved.



NOTE!

The graphical representations in this user manual may differ slightly from the actual design of the device.

1.4 Declaration of Conformity

The device corresponds to the latest standards and EU directives.

We certify this in the CE Declaration of Conformity.

The Declaration of Conformity can be downloaded online from our homepage.

2. SAFETY

This section provides an overview of all-important safety aspects.

In addition, each chapter provides precise safety instructions for the prevention of dangers which are marked with symbols. Moreover, the pictograms, signs and labels found on the device are to be observed and kept in legible condition.

The observance of all safety information enables optimal prevention of all hazards and ensures safe and trouble-free operation of the device.

2.1 General

The device is built according to the state-of-the-art technology. However, dangers may arise from this device if it is improperly used or not used according to its purpose.

Knowing the contents of the user manual is a prerequisite in order to protect yourself from danger, as well as avoid mistakes and thus operate the device safely and without interference.

To avoid danger and to assure optimum performance, no modifications or alterations may be made to the device that are not expressly approved by the manufacturer.

The device may only be operated in a technically perfect and reliable condition.

2.2 Safety instructions for use of the device

The specifications regarding operational safety are based on the regulations of the European Union valid at the time of manufacturing of the device.

If the device is used commercially, the operator is obliged, during the entire period of use, to determine the compliance of the designated occupational safety measures with the current state of regulations and take note of new regulations. Outside the European Union, work safety laws and regional regulations applicable at the place where the device is used must be observed.

Besides the industrial safety instructions in this user manual, the generally valid safety and accident prevention regulations for the application of the device, as well as environment protection regulations, must be observed and complied with.



ATTENTION!

- This device is not intended for use by individuals (including children) with reduced physical, sensory, or mental capabilities. It may also not be used by individuals who lack experience and/or knowledge unless they are supervised by a person responsible for their safety or have received instructions on how to use the device from any such authorized person.
- Children should be supervised to ensure that they do not play with the device.
- Keep this user manual in a safe place. If the device is passed on to a third party, the user manual must be handed over.
- All persons using the device must comply with the specifications in the user manual and follow the safety instructions.

2.3 Intended Use

The reliability of the device is only guaranteed if used properly in accordance with the specifications in the user manual.

Any technical interventions, assembly and maintenance are to be made by qualified service personnel.

The "Cold-Hot Well" is for keeping dishes **warm** or **cool** (**not** for **warming** or **cooling**) of prepared dishes.



ATTENTION!

Any and all use diverting from and/or going beyond the limits of the device is forbidden and is considered to be improper.

Any claims against the manufacturer and/or its agents for damages resulting from improper use of the device are excluded.

The operator is liable for all damages resulting from improper use.

3. TRANSPORT, PACKAGING AND STORAGE

3.1 Transport inspection

The delivery must be checked immediately upon receipt for completeness and transport damage.

In case of visible transport damage, do not accept the delivery, or only do so conditionally.

The extent of the damage on the transport has to be marked on the documents / delivery note. Initiate complaint.

A complaint regarding hidden damage has to be reported, immediately after discovery, as claims for damages can only be asserted within the effective period for complaints.

3.2 Packaging

Do not throw away the cardboard packaging of your device. It might be useful for storage purposes, when moving or if the device needs to be sent to our service centre in case of damage. The outer and inner packaging material has to be removed from the device before use.



NOTE!

If you want to dispose of the packing, consider the regulations applicable in your country. Recycle re-usable packing materials.

Please check that the device and its accessories are complete. If any part is missing, please contact our customer service center immediately.

3.3 Storage

Keep the package closed until installation, under consideration of the indicated positioning and storage markings.

Store the packages under the following conditions:

- Do not store outdoors.
- Keep dry and free of dust.
- Do not expose to aggressive media.
- Protect from direct sunlight.
- Avoid mechanical vibrations.



ATTENTION!

The device shall not be turned upside down.

4. TECHNICAL DATA

4.1 Technical Specifications

Description:	Cold-Hot Well			
Variants:	Installation Variants: plug-in or remote cooling system (Z) or On Counter Variants (A)			
Sizes:	GN1	GN2	GN3	GN4
Amount Refrigerant Plug-in / On Counter [Gram]:	~ 38	~ 39	~ 40	~ 80
Material:	Well: Stainless Steel 1.4031			
Temperature Range:	-5 °C to +140 °C, continuously adjustable			
Refrigerant for remote cooling system:	R134a, R404a, R507a			
Refrigerant Plug-in / On Counter:	R600a	R600a	R600a	R600a
Heating Capacity [Watt]:	900	1500	2700	3000
Cooling Performance [Watt]:	100	100	100	100
Power Requirement:	230 V ~ 50/60 Hz			
Dimensions Plug-in [mm]:	B425xT630xH250	B770xT630xH250	B1110xT630xH250	B1450xT630xH250
Dimensions Remote cooling system [mm]:	B425xT630xH230	B770xT630xH230	B1110xT630xH230	B1450xT630xH230
Dimensions On Counter Metal [mm]:	B410xT615xH275			
Dimensions On Counter Wood Line [mm]:	B440xT645xH275			
Cut-Out Dimensions [mm]:	B375xT580	B720xT580	B1060xT580	B1400xT580
Noise level [dB(A)]:	49,9	59,3	59,3	59,3
Condensing Temperature Plug-in / On Counter [°C]:	-12,1	-12,1	-12,1	-12,1

Subject to Modifications!

4.2 Product Diagram

4.2.1 Installation Variant – plug-in (diagram size GN1)

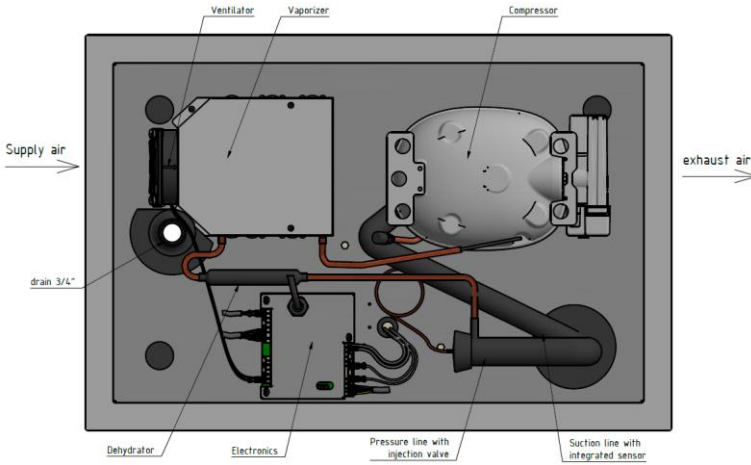

4.2.2 Installation Variant – Remote Cooling System (diagram size GN1)

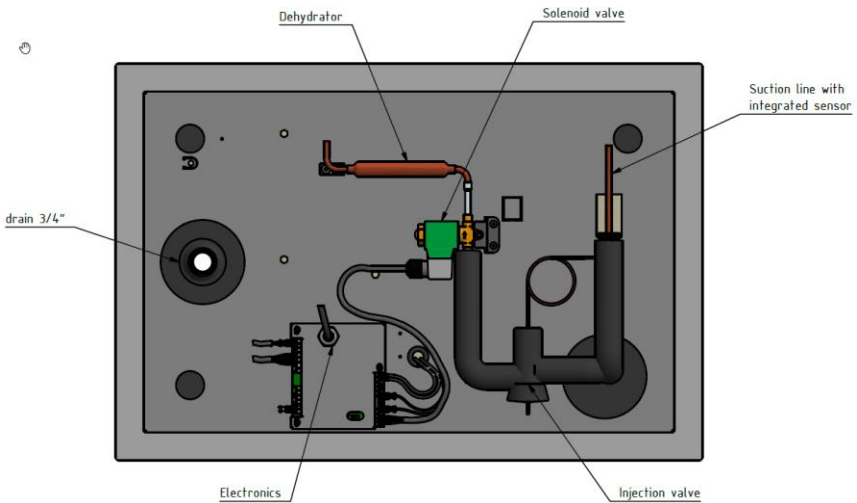

4.2.3 On Counter - (diagram size GN1)

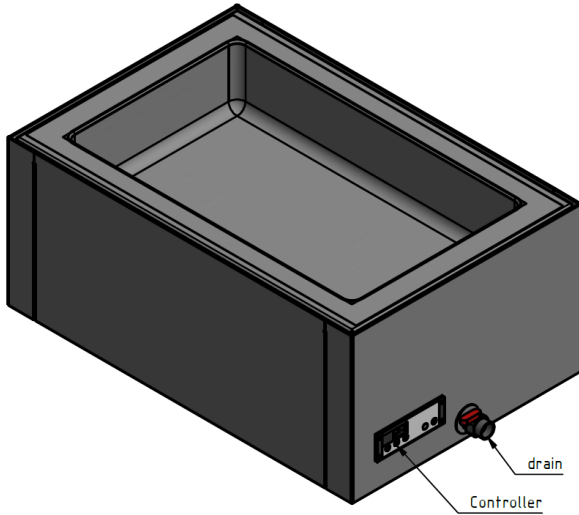

4.3 Scope of Supply

Varies between plug-in, remote cooling system and on counter.

Variant	Plug-in	Remote cooling system	On Counter
Connection cable with Schuko plug 1,6 m	•	•	•
Controller with cable length 1,2 m	•	•	•*
User manual	•	•	•
Connection plan circuit board	•	•	

*controller already installed

5. INSTALLATION AND OPERATION

5.1 Safety information



WARNING! Risk of electrocution!

The device must be installed by qualified professionals.

- Device may cause injuries due to improper installation!
- Before installation, check the data of the local power grid with the technical specifications of the unit (see nameplate).
- Connect the device only if they match! Follow the safety instructions!
- The device may only be operated when connected to a properly installed single socket with protective contact. Don't use any multiply sockets. A safety switch is mandatory when installing a unit.
- Do not pull the plug from the socket by the cable.
- The power cord must not come into contact with hot parts.



WARNING! Hot surface!

During operation, some parts of the device become very hot. To avoid burns, do not touch hot parts!

- Do not use this device if it is not working properly, is damaged or has been dropped.
- Do not use any accessories and spare parts which are not recommended by the manufacturer. These could pose a hazard to the user or cause damage to the device and cause personal injury, and also void the warranty.
- Do not lay the cable over carpets or other heat insulation. Do not cover the cable. Keep the cable away from work areas and do not immerse in water.
- Do not move the device during operation and do not tip it over.
- Never heat food or liquids in sealed containers or bottles. This builds up a pressure which can cause the container or bottle to explode.
- The Cold-Hot Wells must not be used as a storage area. Accidental activation or residual heat can cause objects left there to melt or burn.
- Make sure that the cable does not come into contact with heat sources or sharp edges. Do not hang the cable off the table or counter.

5.2 Installation and Electric Connection

5.2.1 Installation (only valid for installation variants)

- Put your device on a level and safe surface which stands the weight of the device.
- For Dekton (artificial stone) and stone plates please refer to the stone manufacturer's references.
- Make sure the surface is free from dust and grease.
- Put your well into the cut-out and adjust the accurate height with the adjusting screws. Please make sure that the well fits exactly.
- Connect the controller and both cables to the circuit board according to the connection plan.
- Locate the well in the middle of the cut-out.



NOTE regarding the Installation

- The device has to be installed in vertical position.
- The Cold-Hot Well has to left in vertical position at least 15 minutes before operation.
- The supply and exhaust air must be ensured for all the plug-in units.
The ambient temperature of 30°C mustn't exceed in operation (heat accumulation) because the cooling performance decreases and the device might get damaged. Please note that warm air rises. Please use parts of the wide range of built-in accessories like fans or tubes in adverse built-in situations. Referring to this, the qualified professional can give you some advices.



ATTENTION!

The device must be installed by qualified professional.

5.2.2 Electrical connections

- The socket circuit must be secured according to the performance details.
- Connect the controller to the circuit board.
- Plug the Schuko plug into the socket.

5.3 Operation

- Clean the device prior to use as described in chapter 6.2 "Cleaning".









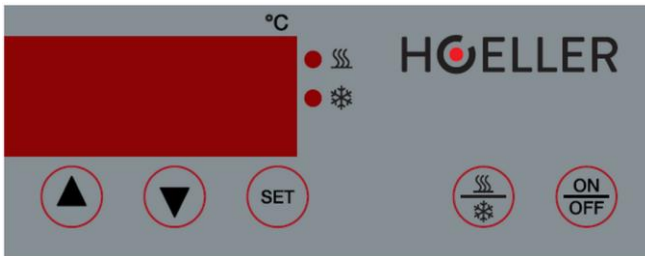



- Press the  button to switch on the device.

- Do not place food directly on the surface. All foods should always be placed in appropriate containers on the surface of the Cold-Hot Well. Use only suitable tableware. **Do not use plastic tableware.**
- Do not use pots or pans with a bottom which has ridged edges or is unevenly enameled. This can cause permanent scratches.

5.3.1 Control panel

The Cold-Hot Well can be set and operated via the touch control panel mounted on the front. The five buttons are used for adjusting settings, switching (between heating or cooling mode), quick choice between preset values, as well as parameterization. Only press the buttons using a finger or a Touchpen.



ON/OFF button 	With this button the device is turned on or off. When turning it on, the last selected mode starts.
Button  	These buttons are for adjusting the temperature.
Button 	By pressing the  button, the adjusted temperature will be shown in the display. To change the temperature press  and either  or  , to adjust the temperature accordingly.
Selection button 	The button is used to switch between the heating or cooling mode. The respective preset setpoint is effective for control.
Display Hot Mode: 	The device is in heating mode.
Display Cool Mode: 	The unit is in cooling mode.
Digital display:	Shows the actual and by pressing the  button the target temperature.



ATTENTION!

A change in the preset parameters should only be carried out by customer service.

When switching from heat to cooling mode, the compressor will only start once an actual temperature of +40°C has been reached.

When turning the device off at a temperature over 40°C, the ACTUAL temperature and OFF flash alternately in the digital display.

6. CLEANING AND MAINTENANCE

6.1 Safety instructions for cleaning

- Before cleaning and before repairing, disconnect the device from the outlet (pull the plug!) and allow it cool.
- Do not use caustic cleaning agents and make sure that no water seeps into the device.
- To protect yourself from electric shock, do not immerse the device, cable or socket in water or other liquids.



ATTENTION!

The device is not suited for direct washing with a water jet. Therefore, do not use a pressure water jet to clean the device!

6.2 Cleaning

Clean the device regularly with a neutral cleaning agent!

- Before cleaning the device, switch it off with the  button and disconnect from the electrical outlet (pull the plug!).
- Leave the device to cool.
- Afterwards clean the surface with a damp cloth.
- Do not use abrasives that could scratch the surface of the Cold-Hot Wells.
- **Never** scrape the painted surface of the Cold-Hot Well with a knife, fork, metal scrapers or other sharp objects, nor use abrasives, steel wool or similar.
- After cleaning, use a soft cloth to dry and polish the surface.

6.3 Safety instructions for maintenance

- Check the main cable for damage from time to time. Do not use the device if the cable is damaged. If the cable is damaged, it must be replaced by customer service or a qualified electrician to avoid risks.
- In case of damage or malfunction, please contact your dealer or our customer service department. Keep in mind the information on troubleshooting in section 7.
- Maintenance and repair work may only be performed by qualified professionals using original spare parts and accessories. **Never try to carry out repairs to the device yourself.**

6.4 Maintenance

- Check in regular periods if the evaporator is dirty and let it clean by a qualified professional if necessary.
- The Cold-Hot Well has to be heated up to high temperature regularly, to avoid humidity and damages.

7. POSSIBLE MALFUNCTIONS

Problem	Cause	Remedy
No function	<ul style="list-style-type: none"> • Power plug not plugged in properly • Fuse of the power supply has tripped. • Controller not plugged in properly 	<ul style="list-style-type: none"> • Pull out the plug and insert it correctly • Check fuse, test unit on a different elec. socket. • Note connection plan
No display function	<ul style="list-style-type: none"> • Controller cable disconnected • Controller cable not connected correctly 	<ul style="list-style-type: none"> • Check the connection • Note connection plan
No cooling	<ul style="list-style-type: none"> • Compressor turned off • Temperature controller faulty • Temperature above 40 °C 	<ul style="list-style-type: none"> • Check supply and exhaust air • Contact the seller • Allow device to cool down to below 40 °C
No heating	<ul style="list-style-type: none"> • Power supply interrupted • Heating element is faulty • Temperature controller faulty 	<ul style="list-style-type: none"> • Check power supply • Contact the seller • Contact the seller
Bad cooling	<ul style="list-style-type: none"> • Evaporator dirty • Fan dirty • Overheating on installation site 	<ul style="list-style-type: none"> • Cleaning by service engineer • Cleaning by service engineer • Check supply and exhaust air
Display shows “FIH” or “Fill”	<ul style="list-style-type: none"> • Broken sensor 	<ul style="list-style-type: none"> • Contact the seller
Temperature varies for more than 20° C	<ul style="list-style-type: none"> • Broken sensor 	<ul style="list-style-type: none"> • Contact the seller • Don't further use the device to prevent subsequent damage

The problems listed above are for guidance and must be seen as examples. Should these or similar problems occur, immediately turn off the device and discontinue use. Contact a qualified specialist or the manufacturer immediately.

Noise during operation (only for compact system)

To keep the selected temperature constant when cooling, from time to time, the Cold-Hot Well switches the compressor of the cooling unit on. The sounds which occur are related to

functionality. They will reduce automatically as soon as the unit has reached operating temperature. The humming noise comes from the compressor.

8. DISPOSAL

Old equipment

Your old device must be disposed of at the end of its service life in accordance with local regulations. It is advisable to contact a specialized waste management company, or to contact the local disposal service in your community.



NOTE!



For the disposal of the device, pay attention to the regulations which apply in your country and region.

9. CONFORMANCE DECLARATION

Josef Höller GmbH
Peter-Mitterhofer-Straße
3300 Amstetten
Austria

HÖELLER

DECLARATION OF CONFORMITY

With this declaration,

**Josef Höller GmbH
Großküchentechnik
Peter-Mitterhofer-Straße 4
A-3300 Amstetten**

hereby declares, at its sole responsibility, that the products described below

**Cold-Hot Well
Built-in Variants**

- **Plug-in**
- **Remote Cooling System**

On Counter Variant

Year of Manufacture: 2020

to which this declaration is applicable, has been manufactured in compliance with the standards, regulations and generally accepted rules of technology listed below.

- | | |
|--|--------------------|
| • Machinery Directive | 2006/42/EG |
| • Low Voltage Directive | 2014/35/EG |
| • Electromagnetic Compatibility | 2014/30/EG |
| • Safety of Machinery | EN ISO 12100 |
| • Electrical Equipment | EN 60204-1 |
| • Restriction of the use of certain hazardous substances
in electrical appliances | 2011/65/EU (RoHS2) |

Josef Höller GmbH holds documentation ready for inspection as proof of compliance with the safety objectives and the essential safety requirements.

Amstetten, 01.10.2020

HÖELLER
holler@holler.com

Josef Höller GmbH
Peter-Mitterhofer-Straße 4
3300 Amstetten
Austria
T +43 7472 233 29
office@holler-solutions.com

Josef Höller GmbH
Stamp and Signature

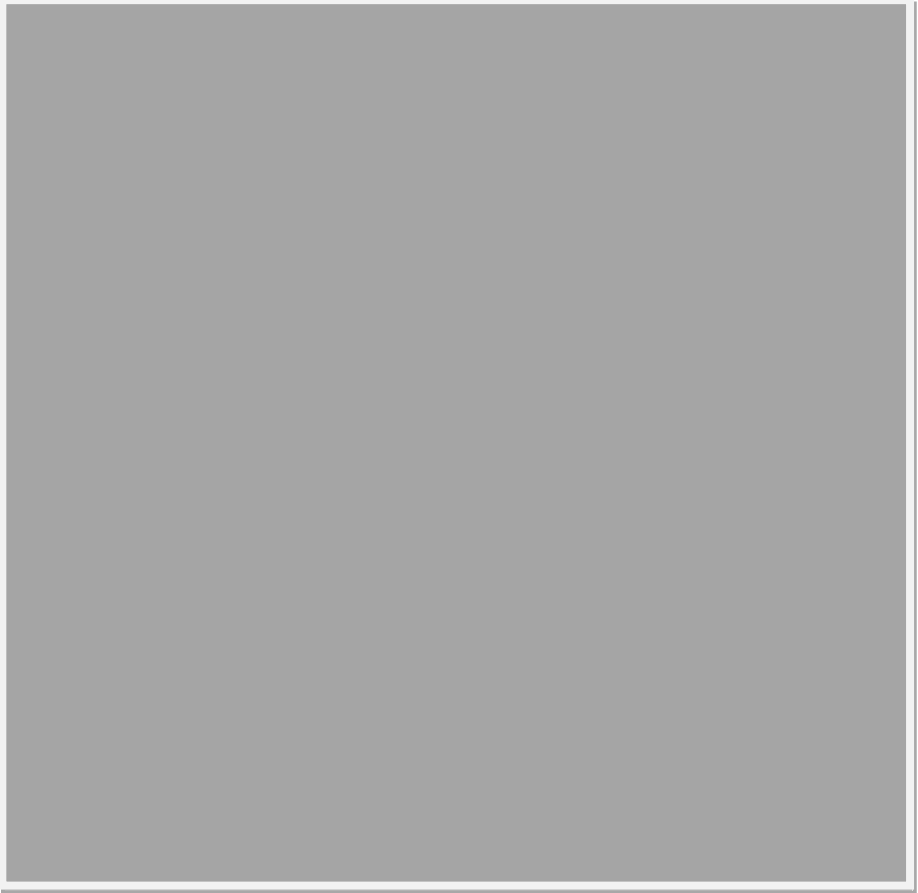

Josef Höller GmbH
Peter-Mitterhofer-Straße 4
3300 Amstetten

Tel.: +43 7472 233 29
office@hoeller-solutions.com

HOELLER