

View from below (1 : 6)

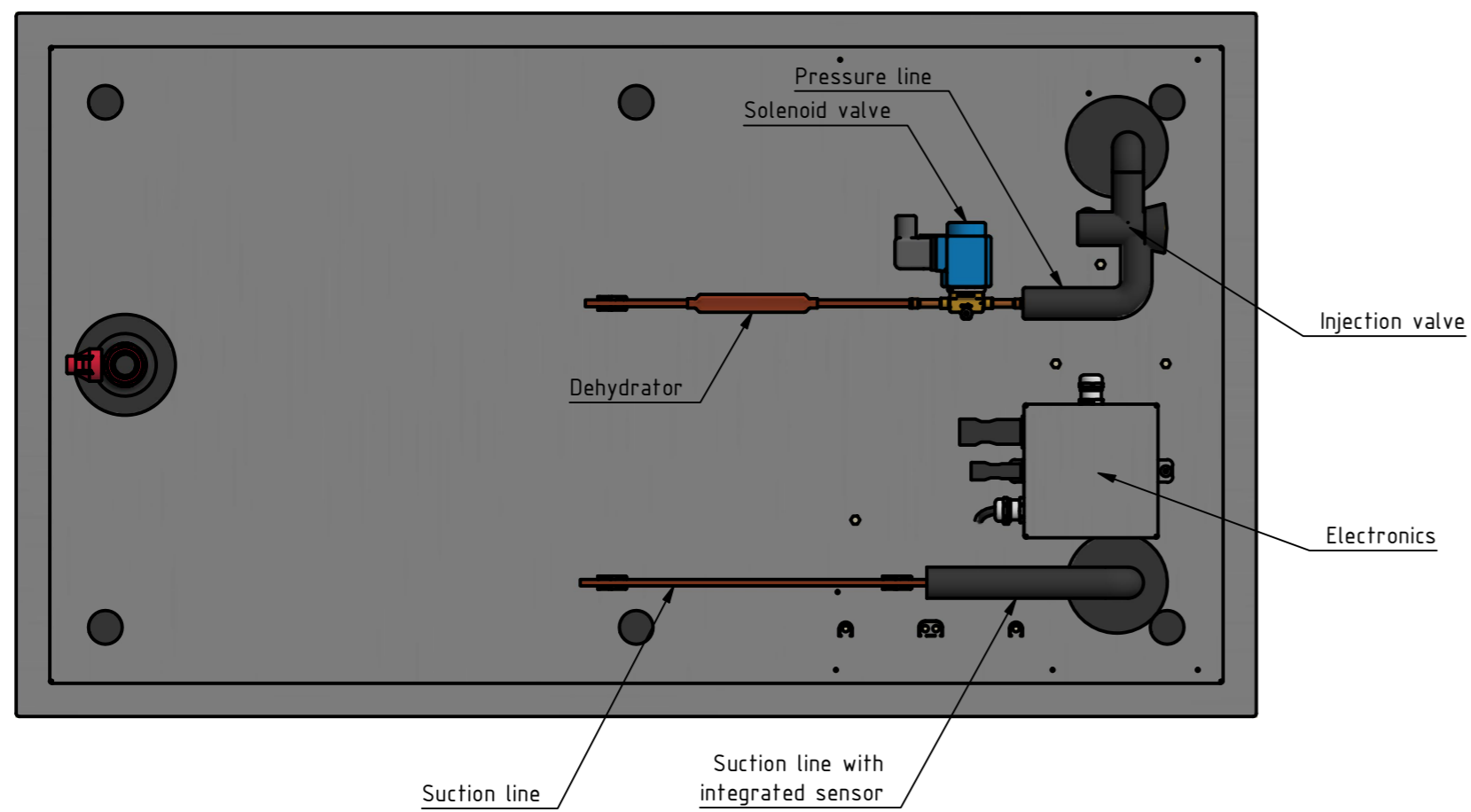
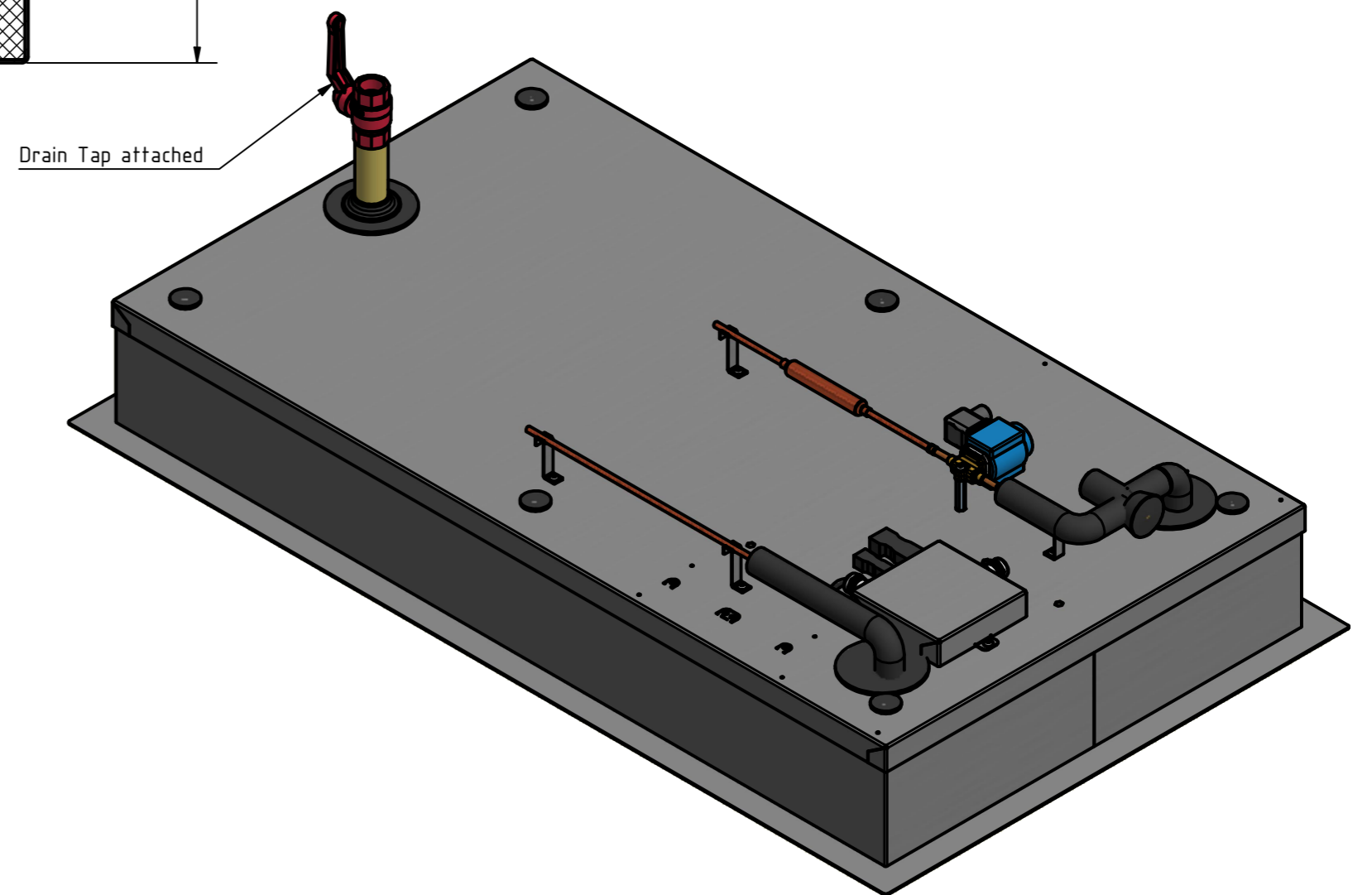

A	Initial Release	10.05.2021	SH
Rev.	Änderungsbeschreibung / Change Description	Datum / Date	Genehmigt / Approved

Format overview		
Format	External dimensions	Cut-out dimensions
GN1	425 x 630	375 x 580
GN2	770 x 630	720 x 580
GN3	1110 x 630	1060 x 580
GN4	1450 x 630	1400 x 580

HOELLER
Consider protection frank ISO 16016

Date:	01.04.2021	Material:	
Name:	SH	Surface:	
Denomination:			
Cold-Hot Well - Z GN3			
Sheet size:	A2	Scale:	1 : 6
Item number:	14360000		